

— Important Notice —



This is an office consolidation and not an official version of this Act or Regulation. While care has been taken in assembling this document, it is not warranted to be true and accurate. Official copies of all Provincial Acts and Regulations are available from [Island Information Service](#).

All Prince Edward Island Statutes and Regulations are available on-line (in PDF format) at the [Office of the Legislative Counsel](#).

- Updated to: December 15, 2010 -

(Includes Amendments Approved on November 30, 2010)

(Click [HERE](#) for Previous Version of this Regulations)

CHAPTER R-15

ROADS ACT

VEHICLE WEIGHTS AND DIMENSIONS REGULATIONS

Pursuant to section 55 of the *Roads Act* R.S.P.E.I. 1988, Cap. R-15, Council made the following regulations:

Definitions

1. In these regulations

Act

(a) "Act" means the *Roads Act*;

A dolly

(b) "A dolly" means a converter dolly that is towed from one hitch on the centre line of the towing vehicle;

all-weather highway

(c) "all-weather highway" means a highway designated in Schedule 1;

A, B or C train highway

(d) Revoked by EC481-10;

A train double

(e) "A train double" means a combination of vehicles consisting of a truck tractor, a semi-trailer and either an A Dolly and a semi-trailer, or a full trailer attached to the foremost semi-trailer in a like manner as if an A Dolly were used;

axle group

(f) "axle group" means a single axle, a tandem axle group, a tandem equivalent, a tridem axle group or a tridem equivalent axle;

axle group weight

(g) "axle group weight" means the total weight transmitted to the road by an axle group;

axle spread

(h) "axle spread" means the longitudinal distance between the centers of an axle group;

axle weight

(i) "axle weight" means the weight transmitted to the road by an axle;

"B train double"

(j) "B train double" means a combination of vehicles consisting of a truck-tractor, a semi-trailer, and a second semi-trailer towed by the lower half of a fifth wheel assembly mounted on the rear of the foremost semi-trailer;

box length

(k) "box length" means, for a combination of vehicles, the external longitudinal dimension from the foremost part of the cargo carrying unit or load to the rearmost part of the cargo carrying unit or load, exclusive of any extension in the dimension caused by auxiliary equipment or machinery at the front that is not designed or used for the transportation of goods;

C dolly

(l) "C Dolly" means a trailer converter dolly, with a frame rigid in the horizontal plane that is towed from two hitches located in a horizontal transverse line on the towing vehicle, that precludes any rotation in the horizontal plane about the hitch points, and which satisfies all requirements of the Canadian Motor Vehicle Safety Standards under the *Motor Vehicle Safety Act* (Canada) applicable to such devices;

conspicuity marking

(m) "conspicuity marking" means a marking, label or similar item made of retroreflective material and affixed to the outer part of the vehicle;

converter dolly

(n) "converter dolly" means a vehicle that is designed and normally used to convert a semi-trailer to a full trailer, and consists of a drawbar, a frame, one or more axles and the lower half of a fifth wheel assembly;

C train double

(o) "C train double" means a combination of vehicles consisting of a truck-tractor, a semi-trailer, a C dolly and a second semi-trailer, as shown in Schedule 3;

dimension "A"	(p) "dimension "A"" means the distance between the centre of the last axle on the lead semi-trailer and the centre of the first axle on a converted dolly or second trailer, as the case may be;
drawbar	(q) "drawbar" means a structure connected to the chassis frame of a trailer or converter dolly that includes a device for coupling to a hitch on a towing vehicle;
drawbar length	(r) "drawbar length" means, for a converted dolly, the longitudinal distance from the centre of a device that attaches to a hitch on a towing vehicle to the center of the lower half of the fifth wheel or turntable;
drive axle	(s) "drive axle" means the axle or axle group that is or may be connected to the power source of a motor vehicle and that transmits power to the wheels;
effective rear overhang	(t) "effective rear overhang" means the longitudinal distance from the centre of the rear axle or axle group on a truck or the geometric centre of the rear axle or axle group on a trailer, to the rearmost point of the truck or trailer, including cargo;
end dumping mechanism	(u) "end dumping mechanism" means a hydraulic hoist or other lifting device combined with a tailgate or other dumping device, located on a trailer for removal of load from a trailer;
fifth wheel assembly	(v) "fifth wheel assembly" means coupling device whose lower half consists of a plate and locking jaws mounted on the rear portion of the frame of a vehicle or converter dolly and whose upper half consists of a plate and a kingpin fastened to the underside of the forward portion of a semi-trailer for the purpose of supporting and towing the semi-trailer;
fifth wheel offset	(w) "fifth wheel offset" means, for a tractor, the longitudinal distance from the centre of the the lower half of a fifth wheel assembly to the tractor turn center;
"front overhang"	(x) "front overhang" means the longitudinal distance from the front bumper of a vehicle, as installed by the manufacturer of the vehicle, to the foremost part of the vehicle, or to the cargo, whichever is the farther;
full trailer	(y) "full trailer" means a trailer so designed and used that its weight and load is carried on its own axles and includes a combination consisting of a semi-trailer and a converter dolly;
grandfather program	(z) "grandfather program" means a transitional program established by an applicable authority in a province of Canada for existing vehicles which do not meet minimum requirements in force in the province before the coming into force of these regulations and which, for a defined time period, exempts the vehicles from the requirements or which permits them to meet less stringent requirements;
gross axle weight rating	(aa) "gross axle weight rating" means the value specified by a vehicle manufacturer as the cargo-carrying capacity of a single axle system of a vehicle, as measured at the tire-ground interfaces;
gross vehicle weight	(ab) "gross vehicle weight" means the total weight transmitted to the road by a vehicle or combination of vehicles and cargo;
gross vehicle weight rating	(ac) "gross vehicle weight rating" means the value specified by a vehicle manufacturer as the loaded weight of a single vehicle;
hitch	(ad) "hitch" means a device attached to a vehicle or converter dolly for towing another vehicle or converter dolly and includes the lower half of a fifth wheel assembly;
hitch offset	(ae) "hitch offset" means, for a truck or semi-trailer equipped with a hitch for towing a trailer or converter dolly, the longitudinal distance from the turn center of the truck or semi-trailer to the articulation point of the hitch;
interaxle spacing	(af) "interaxle spacing" means the longitudinal distance between the center of the rearmost axle of an axle group and the center of the foremost axle of the next axle group to the rear, within a vehicle or combination of vehicles;
intercity bus	(ag) "intercity bus" means a vehicle that is designed to carry more than 10 passengers and that is equipped with facilities to allow extended travel without stopping, and includes such a vehicle modified for use as a motor home;
kingpin	(ah) "kingpin" means the pin that couples a semi-trailer to the lower half of a fifth wheel assembly;
kingpin setback	(ai) "kingpin setback" means the horizontal distance from the vertical axis through the centre of the kingpin to any point on the semi-trailer or cargo ahead of the kingpin;
length	(aj) "length means <ul style="list-style-type: none"> (i) with respect to a full trailer, the external longitudinal dimension from the front of the cargo carrying section of the trailer or cargo to the rearmost part of the trailer or cargo, exclusive of any extension in length caused by equipment or machinery at the front that is not designed for the transportation of goods; (ii) with respect to a pony trailer, the external longitudinal dimension from the front of the drawbar of the pony trailer or cargo to the rearmost part of the trailer or cargo, (iii) with respect to a semi-trailer, the external longitudinal dimension from the front of the foremost cargo carrying section of the semi-trailer or cargo to the rearmost part of the semi-trailer or load, exclusive of any extension in length caused by equipment or machinery at the front that is not designed for the transportation of goods, and

(iv) with respect to a truck, the external longitudinal distance from the foremost part of the truck, including cargo, to the rearmost part of the truck, including cargo;

lift axle	(ak) "lift axle" means an axle fitted with a device which enables its load to be adjusted or which can be removed from contact with the ground by the vehicle operator;
load equalization	(al) "load equalization" means that the observed weight on tandem and tridem axle groups does not vary by more than 1,000 kg between adjacent axles;
model year	(am) "model year" means the year used to designate a discrete vehicle model irrespective of the calendar year in which the vehicle was actually produced, as indicated by the vehicle manufacturer in the vehicle identification number;
overall height	(an) "overall height" means the vertical distance between the highest part of the vehicle or combination of vehicles, including load, and the surface of the road;
overall length	(ao) "overall length" means the longitudinal measurement from the foremost part of a vehicle or combination of vehicles, including cargo, to the rearmost part of the vehicle or combination of vehicles, including cargo;
overall width	(ap) "overall width" means the greatest overall transverse dimension of a vehicle or combination of vehicles including cargo;
pony trailer	(aq) "pony trailer" means a trailer with one axle group close to the center of its chassis that carries the preponderance of its weight and load, and that is towed by a drawbar rigidly attached to the structure of the trailer;
rear overhang	(ar) "rear overhang" means the longitudinal distance from the rearmost point of the bed or body of a vehicle to the rearmost point of the cargo;
self-steering axle	(as) "self-steering axle" means an axle whose wheels can steer in response to forces generated between its tires and the road, or through mechanisms and linkages that operate independently of the driver, regardless of whether the self-steering mechanism may be rendered inoperative;
single axle	(at) "single axle" means one or more axles whose centres are included between two parallel transverse vertical planes up to, but not including, 1.2 m apart;
steering axle	(au) "steering axle" means an axle whose steering is controlled by the driver of a vehicle to control the direction of travel of the vehicle;
swing radius	(av) "swing radius" means the horizontal distance from the vertical axis through the center of the kingpin to any point on the semi-trailer or cargo ahead of the kingpin;
tandem axle group	(aw) "tandem axle group" means an axle group containing two consecutive axles which do not include any liftable or self-steering axles, have the same number and size of tires on both axles, and are attached to the vehicle in a manner which achieves load equalization between the axles;
tandem equivalent axle	(ax) "tandem equivalent axle" means an axle group on a vehicle consisting of two consecutive axles, of which one is lowered lift axle, that <ul style="list-style-type: none">(i) are attached to the vehicles so as to achieve load equalization between the two axles, and(ii) have the same number and size of tires on each axle;
tandem steering axle	(ay) "tandem steering axle" means an axle group containing two consecutive axles which do not include any liftable or self-steering axles, have the same number and size of tires on both axles, both of which whose steering is controlled by the driver of a vehicle to control the direction of travel of the vehicle, and are attached to the vehicle in a manner which achieves load equalization between the axles;
tire rated capacity	(az) "tire rated capacity" means the maximum weight for a tire as printed on the side of the tire by the manufacturer;
tire width	(ba) "tire width" means the width of the tire as customarily measured and rated by the tire manufacturer and stamped on the tire at the time of its manufacture;
track width	(bb) "track width" means the overall width of an axle across the outside faces of the tires;
tractor wheelbase	(bc) "tractor wheelbase" means the longitudinal distance from the centre of the steering axle to the geometric centre of the drive axle unit;
trailer wheelbase	(bd) "trailer wheelbase" means the longitudinal distance from the centre of the kingpin of a semi-trailer, or the centre of the turntable of a full trailer, or the centre of the hitching device on a pony trailer, to the trailer turn center;
turn centre	(be) "turn centre" means the geometric center of the axle group on semi-trailer or pony trailer, or the rear axle group on a truck, tractor or full trailer;
triaxle	(bf) "triaxle" means an axle group consisting of a tandem axle and one axle that is a single axle or liftable axle or a self-steering axle, and that are the only axles attached to a trailer;

tridem axle group	(bg) "tridem axle group" means three consecutive axles within a vehicle which do not include any liftable or self-steering axles, have the same number and size of tires on all three axles, are equally spaced and are attached to the vehicle in a manner which achieves load equalization among the three axles;
tridem equivalent axle	(bh) "tridem equivalent axle" means an axle group consisting of three consecutive, equally spaced axles within a vehicle that has <ul style="list-style-type: none"> (i) all life axles lowered; (ii) the same number and size of tires on each axle, and (iii) each of its axles attached to the vehicle by identical pneumatic suspension that automatically provide load equalization;
vehicle	(bi) "vehicle" means every device in, on or by which a person or property is or may be transported or drawn on a highway, excepting devices used exclusively on stationary rails or tracks; and
vehicle identification number	(bj) "vehicle identification number" means a number consisting of Arabic numerals, Roman numerals, or both, that the manufacturer assigns to the vehicle for identification purposes. (EC1/02; 481/10)

PART I

DIMENSION AND WEIGHT REQUIREMENTS

Prohibition on gross vehicle weight	2. (1) Subject to subsection (2), no person shall operate or cause to be operated on any highway listed in Schedule 1, a vehicle, whether loaded or not, of any category described in Schedule 4 conforming to the applicable diagram in that Schedule, which is equipped with pneumatic tires and has <ul style="list-style-type: none"> (a) a gross vehicle axle weight in excess of the gross vehicle weight represented on any registration permit granted with respect to the vehicle; (b) an axle group weight for a single axle, tandem axle, tandem equivalent axle, tridem axle, tridem equivalent axle or triaxle in excess of the gross vehicle weight limit shown for those items under the applicable category of vehicle as set out in Schedule 4; (c) a gross vehicle weight in excess of the gross vehicle weight set out in Schedule 4 for the applicable category of vehicle; (d) an axle weight on any axle, either alone or as part of any group of axles, in excess of 10 kg/mm of the tire width, or in excess of the tire rated capacity;
Exception	(2) A person may operate or cause to be operated a vehicle referred to in subsection (1) if that person has been granted a permit under section 46 of the Act.
Maximum allowable weight	(3) A person operating or causing to be operated a vehicle shall ensure the maximum allowable weight for an axle, other than a steering axle, that may be carried by a vehicle or combination of vehicles on a highway or a portion of a highway does not exceed the least of <ul style="list-style-type: none"> (a) the sum of the axle group weights computed by multiplying 10 kg/mm of the tire width for each tire installed on the wheels of the axle, (b) the gross axle weight rating, (c) the tire load weight rating multiplied by the number of tires on the axle, and (d) 6,000 kg, in the case of an axle equipped with two tires rather than four tires.
Modified ratings	(4) Notwithstanding clause (3)(c), in cases where a vehicle has been modified to enable the vehicle to carry a weight in excess of that indicated in the original manufacturer's rating, or the original manufacturer's rating is not available, a new steering axle weight rating indicated by the manufacturer's agent or dealer may be applied if <ul style="list-style-type: none"> (a) the manufacturer's agent or dealer executes and signs the form in Schedule 5; and (b) the owner of the vehicle submits the form to the Minister and requests that the new rating be applied; and (c) the modification does not exceed the original manufacturer's rating by more than 2,000 kg.
Condition	(5) Revoked by EC481-10.
Approval of out of province agent	(6) A manufacturer's agent or dealer located outside of the province who certifies a front axle rating must first be approved by the Minister as a person qualified to issue such certificate.
Offence	(7) It is an offence to make a false or untrue statement or certification on the form in Schedule 5, or to submit to the Minister a form containing a false or untrue statement knowing it to be false or untrue, and a person who commits an offence under this subsection is liable to a fine of \$500 for a first offence and \$1,000 for each subsequent offence.
Idem	(8) Revoked by EC481-10. (EC1/02; 481/10)

Calculation of gross vehicle weight	<p>3. (1) The gross vehicle weight of any vehicle shall be calculated as,</p> <ul style="list-style-type: none"> (a) if all axles are weighed separately, the sum of the axle weights; or (b) if the vehicle is weighed as a unit, the total weight of the vehicle.
Other considerations	<p>(2) For the purposes of calculating gross vehicle weight,</p> <ul style="list-style-type: none"> (a) tandem axle or tandem equivalent axles with interaxle spacing of less than 1.2 m shall be counted as a single axle; and (b) tridem axles, tridem equivalent axles and triaxles with an interaxle spacing of less than 2.4 m shall be counted as two axles. (EC1/02)
Permissible weight, solid tire vehicle	<p>4. No person shall operate or cause to be operated on any highway, a vehicle whether loaded or not, equipped with solid tires, whether rubber or otherwise, having a weight in excess of 50% of the weight permitted for vehicles of the same type equipped with pneumatic tires. (EC1/02)</p>
Maximum allowable weight	<p>5. No person shall, without a permit granted by the Minister under section 46 of the Act, move a vehicle, other than a motor vehicle, or any object on wheels or rollers or otherwise having a gross vehicle weight in excess of the maximum allowable weight limit set out in Schedule 4 for the applicable category of vehicle, over or on any highway. (EC1/02)</p>
Application of spring weight restrictions	<p>6. (1) Where the Minister sets spring weight restrictions pursuant to section 54 of the Act, those restrictions shall apply to the carriage of the following commodities on the highway:</p> <ul style="list-style-type: none"> (a) livestock feed; (b) livestock; (c) milk; (d) potatoes; (e) fish.
Mode of travel	<p>(2) All vehicles carrying the commodities referred to in subsection (1) during spring weight restrictions shall</p> <ul style="list-style-type: none"> (a) proceed from the place of origin to the nearest all-weather highway by the shortest distance available; (b) continue to travel on all-weather highways; and (c) proceed from the nearest all-weather highway to the place of destination by the shortest distance available.
Bulk milk transportation	<p>(3) The following rules apply to bulk milk transportation:</p> <ul style="list-style-type: none"> (a) any person or company transporting bulk milk shall submit a plan for approval to the Minister, in accordance with clause 54(1)(b) of the Act, describing the routes travelled by vehicles; (b) no person shall operate on a highway a vehicle carrying bulk milk unless the vehicle is on a highway described in a plan approved in accordance with clause (a).
Determination of load	<p>(4) Where a peace officer, during spring weight restrictions, has reasonable cause to believe a vehicle is carrying a commodity other than a commodity referred to in subsection (1), the peace officer may</p> <ul style="list-style-type: none"> (a) require the driver of such vehicle to produce the documentation or bill of lading for the vehicle load for examination by the peace officer; or (b) the peace officer may search the vehicle for the purpose of identifying the commodity carried in the vehicle.
Failure to produce documentation	<p>(5) Any person who fails to comply with a requirement under this section is guilty of an offence and is liable to a fine of \$500 for a first offence and \$1,000 for each subsequent offence. (EC1/02; 481/10)</p>
Axle tolerance	<p>7. A person shall not exceed the axle weight limit prescribed in the regulations as modified by any weight tolerance set by the Minister under section 54 of the Act. (EC1/02)</p>
Offences and penalties	<p>8. (1) A person who violates any of the provisions of these regulations relating to axle weight or load and the operation of a motor vehicle shall be liable for the first offence to a fine of not more than \$50 and for any subsequent offence to a fine of not more than \$200 and, in addition, shall be liable to pay a further penalty calculated on the excess weight or load, as follows:</p> <ul style="list-style-type: none"> (a) \$1 for each 50 kg or fraction thereof on the first 500 kg of such excess weight or load; (b) \$2 for each 50 kg or fraction thereof on such excess weight or load over 500 kg; (c) \$2 for each 50 kg or fraction thereof on such excess weight or load over 2,000 kg.

<i>Idem</i>	<p>(2) During the period when weight restrictions set by the Minister under section 54 of the Act with respect to all-weather highways and commodities referred to in subsection 6(1) are in force, a person who violates any of the provisions of these regulations relating to axle weight or load and the operation of a motor vehicle shall be liable for a first offence to a fine of not more than \$50 and for any subsequent offence to a fine of not more than \$200 and, in addition, shall be liable to pay a further penalty calculated on the excess weight or load, as follows:</p> <p>(a) \$3 for each 50 kg or fraction thereof on the first 500 kg of such excess weight or load;</p> <p>(b) \$6 for each 50 kg or fraction thereof on such excess weight or load over 500 kg;</p> <p>(c) \$6 for each 50 kg or fraction thereof on such excess weight or load over 2,000 kg. (EC1/02)</p>
Prohibition on vehicle dimensions	<p>9. (1) Subject to subsection (2), no person shall operate or cause to be operated or moved on any highway, a vehicle, whether loaded or not, of any category described in Schedule 4 conforming to the applicable diagram in that Schedule, which is equipped with pneumatic tires and has an overall height, width and length of no more than the maximum allowable dimension limit set out in Schedule 4 for that category of vehicle.</p>
Exception	<p>(2) A person may operate or cause to be operated or moved a vehicle referred to in subsection (1) if that person has been granted a permit under section 46 of the Act. (EC1/02)</p>
Requirements regarding length-semi-trailers	<p>10. (1) Subject to subsection (2), all trailers and semi-trailers greater than 14.2 m but less than 16.2 m shall have</p> <p>(a) automatic slack adjusters on all wheels;</p> <p>(b) conspicuity markings;</p> <p>(c) no liftable axles; and</p> <p>(d) rear impact guards.</p>
A, B and C train doubles	<p>(2) All 23 to 25 m A, B and C train doubles shall have</p> <p>(a) automatic slack adjusters on all wheels;</p> <p>(b) conspicuity markings;</p> <p>(c) no liftable axles; and</p> <p>(d) rear impact guards.</p>
Exception	<p>(3) The trailers and semi-trailers referred to in subsections (1) and (2) may have liftable axles on tandem equivalent or tridem equivalent axles.</p>
Semi-trailers conspicuity markings	<p>(4) All trailers and semi-trailers operating on a highway after January 1, 2002 or manufactured before December 1, 1993 shall have conspicuity markings in conformity with section 5.71 of Technical Standards Document No. 108 issued by Transport Canada, as amended from time to time.</p>
Rear impact guard	<p>(5) All trailers and semi-trailers manufactured after January 1, 1995 that are greater than 14.2 m but less than 16.2 m in length shall have a rear impact guard consisting of a single horizontal beam that is rigidly attached to the semi-trailer as follows:</p> <p>(a) it is attached beneath and frontward of the rear of the semitrailer, as close to the rear as practicable, so that the space between the rear of the semi-trailer and the rearmost side of the guard does not exceed 30.0 cm;</p> <p>(b) it extends across the bottom of the semi-trailer so that the ends are inside the sides of the semi-trailer within 10.0 cm of each side;</p> <p>(c) its bottom side is not more than 56.0 cm above the ground when the semi-trailer is not loaded and is stopped on a level surface. (EC1/02)</p>
Other requirements	<p>11. No person shall operate or cause to be operated or moved on a highway a C train double unless the C train double is equipped with a C dolly that meets the requirements set out in sections 903 and 904 of Schedule IV of the Motor Vehicle Safety Regulations under the <i>Motor Vehicle Safety Act</i> (Canada). (EC1/02)</p>
Permit violation	<p>12. A person who fails or neglects to observe any of the terms or conditions of a permit issued under the Act shall be liable, in addition to any other penalty which may otherwise be applicable under the Act or these regulations, to a further penalty of a sum of \$200 for a first offence and \$500 for each subsequent offence. (EC1/02)</p>

PART II

TRANSITIONAL AND MISCELLANEOUS PROVISIONS

- Existing vehicles under grandfather program
- Formula in Schedule 6 to apply
- Vehicles of model year 2002 or earlier compiling with provincial requirements
- Existing vehicles not complying with new or former requirements
- 2002 or older tractor semi-trailer with non-compliant end dumping mechanism
- Trailers with greater than 1.85 m spread on tandem axle groups
- Idem*, weight limit as of January 1, 2010
- Trailers with greater than 3.7 m spread on tridem axle groups or triaxle equivalents
- Idem*, weight limit as of January 1, 2010
- 2002 or older triaxle trailers
- New triaxle trailers
- Permit
- General penalty
- Revocation
13. (1) An existing vehicle which does not meet prescribed minimum requirements for the applicable category of vehicle as set out in Schedule 4 and is subject to a grandfather program shall continue to operate under the program until it ends.
- (2) At the end of the grandfather program, the formula set out in Schedule 6 shall apply to the prescribed requirements set out in Schedule 4 in respect of a vehicle which continues to not meet those requirements.
- (3) An existing vehicle with a model year of 2002 or earlier which does not meet the prescribed requirements for the applicable category of vehicle as set out in Schedule 4, but which complies with the applicable requirements which were in force before these regulations came into force, may operate in accordance with those requirements until December 31, 2009.
- (4) The formula set out in Schedule 6 shall apply to the prescribed requirements for the applicable category of vehicle as set out in Schedule 4 in respect of a vehicle with a model year of 2003 or later which does not meet those requirements or the applicable requirements in force before these regulations were in force.
- (5) A tractor semi-trailer of a model year 2002 or earlier with an end dumping mechanism that does not meet the prescribed dimension requirements for the applicable category of vehicle as set out in Schedule 4, and with an interaxle spacing between the tractor drive axle group and the semi-trailer axle group of at least 2.6 m, may operate
- (a) if the vehicle has a tandem axle, at a maximum allowable weight limit of 18,000 kg; or
- (b) if the vehicle has a tridem axle, at a maximum allowable weight limit of 26,000 kg. (EC481/10)
14. (1) A trailer or semi-trailer with a tandem axle group having axle spacing of more than 1.85 may operate at a maximum allowable weight limit of 18,000 kg.
- (2) The maximum allowable weight limit for trailers and semi-trailers referred to in subsection (1) shall be 9,100 kg. effective January 1, 2010. (EC1/02)
15. (1) A trailer or semi-trailer of a model year 2002 or earlier, with a tridem axle, tridem equivalent axle or triaxle, having an axle spread of more than 3.7 m, shall be subject to a maximum allowable weight limit of 26,000 kg.
- (2) The maximum allowable weight limit for trailers and semi-trailers referred to in subsection(1) shall be 18,000 kg. as of January 1, 2010. (EC1/02; 481/10)
16. (1) A trailer or semi-trailer of a model year 2002 or earlier, with a triaxle, shall be subject to the maximum allowable weight limit of 26,000 kg.
- (2) A new trailer or semi-trailer of a model year 2003 or later, with a triaxle or wheel based dimension which does not meet the requirements of Schedule 4 for that category of vehicle shall be subject to the formula set out in Schedule 6, (EC1/02; 481/10; EC656/10)
17. A person who wishes to operate or cause to be operated on any provincial highway a vehicle which does not conform to these regulations shall apply for a permit under section 46 of the Act. (EC1/02)
18. Except where otherwise provided in these regulations, a person who fails to comply with any of these regulations is guilty of an offence and is liable to a penalty of \$200 for a first offence and \$500 for each subsequent offence. (EC1/02)
19. The Roads Act Vehicle Weights Regulations (EC373/96) are revoked. (EC1/02)

SCHEDULE 1

All-Weather Highways

Route 1	Borden to Wood Islands including the Charlottetown Bypass Road (Grafton Street East - Route 2) to Upton Road
Route 1A	Albany to Summerside and Travellers Rest
Route 1A	From Crossroads to Pownal
Route 2	Souris to Tignish
Route 3	Cherry Valley to Georgetown
Route 4	Wood Islands to Dingwells Mills
Route 5	From Route 1 East 3.47 km
Route 5	From Route 22 East to Collins Road
Route 6	Kensington to Stanley Bridge Intersection
Route 6	Stanley Bridge to Cavendish
Route 6	Bedford to Corran Ban Bridge
Route 6	Cudmore's Corner (Route 251) to North Rustico
Route 7	From Milton to Route 251 and 6
Route 8	North Bedeque to Freetown
Route 8	From Route 2 South 1.34 km
Route 9	From Route 1 North 3.50 km
Route 9	From Route 235 to Route 225
Route 10	Carleton Siding to North Carleton Route 112
Route 11	Portage Road from Route 2 in Mount Pleasant West 2.8 km
Route 12	From Route 133 to Route 134
Route 12	From Route 2, Miscouche, to the Grand River Bridge
Route 12	From Route 178 to Route 166 in Tyne Valley
Route 12	From Route 2 in Portage to Route 168
Route 13	From Route 225 in Hartsville to the Snowie Road
Route 13	From Route 6 in Cavendish to Route 241, Toronto Road
Route 13	From Route 235 to Route 246 in Kellys Cross
Route 14	From Carleton to MacPhee Road in Brae
Route 14	From Howards Cove South to Route 164, the Lecky Road
Route 14	From Miminegash South 6.1 km
Route 15	From Charlottetown to Portage Road, Route 6 West
Route 16	Souris to South Lake, Route 16A South
Route 16	From Route 16A East 1.1 km to the road to North Lake Harbour
Route 16A	From South Lake to North Lake
Route 17	From Route 4 to Route 326 in Montague
Route 18	Murray River to Beach Point
Route 18	From High Bank to White Sands, Route 18A
Route 19	From Cornwall to New Dominion, Route 19A
Route 20	Kensington to Darnley Road Intersection
Route 21	From Route 1 East 4.4 km
Route 22	Route 3 to Route 5
Route 22	From Route 2 to Joeys Road in Pisquid
Route 24	From Route 3 to Route 4
Route 25	From Route 2 to Stanhope
Route 101	From Kensington to Route 234
Route 107	Blueshank Road from Route 1A to Route 2
Route 109	From Route 2 South 1.32 km
Route 109	Route 8 to Route 107
Route 110	From Route 2 to Dunk River Road, Route 171
Route 115	From Route 1A to Albany
Route 123	Belmont from Route 12 East 1.0 km
Route 124	From Route 2 to Wellington
Route 127	McIssac Road from Route 2 1.0 km
Route 132	Northam Road from Route 2 to Route 178
Route 133	From Route 2 to Route 12
Route 140	From Barclay Road to Leckie Road
Route 142	Woodstock to West Cape
Route 143	Route 2 to Gaspé Road, Route 148
Route 145	From Route 12 in Alberton to Route 148 in Bloomfield
Route 148	Barclay Road from Route 142 to Route 140
Route 150	Elmsdale to Alberton
Route 152	Alberton to Miminegash
Route 153	Montrose to Tignish
Route 155	From Route 152 to Route 156
Route 156	From Route 155 North 2.25 km
Route 163	From Route 12 East 1.2 km
Route 164	Lecky Road from Route 14 to Route 140
Route 168	From Route 12 to Foxley River to end of the Road
Route 171	Route 1A to Central Bedeque
Route 175	Conway Road from Route 2 in Inverness East 3 km
Route 177	From Wellington to Route 11
Route 178	From Route 132 in Northam to Route 167 in Tyne Valley
Route 210	From Montague to Victoria Cross
Route 210	From Route 24 to Route 325
Route 213	From Route 3 North 1.70 km North
Route 217	From Route 2 to Route 350
Route 223	From Route 2 to Route 250
Route 224	From Route 6 South 3.7 km to the Centre Road
Route 225	From Route 1A to Route 248
Route 226	Route 2 to Route 225
Route 231	From Route 2 to Breadalbane
Route 235	Route 248 to Route 13
Route 236	Lower Malpeque Road, Trans Canada Highway to Route 2
Route 248	From Route 225 to York Point in Cornwall
Route 254	From Route 2, 1.25 km North
Route 258	New Glasgow to Anglo Rustico
Route 267	From Route 270 to end of pavement, Earnscliffe
Route 268	From Route 270 North to Route 270 South
Route 270	From Trans Canada Highway to Route 267

Route 270	From Route 268 to McInnis Point
Route 301	From Route 16, 2.4 km North
Route 301	From Route 16, 1.94 km South
Route 308	From Route 2 to Sheehan Road
Route 311	From Route 4 to Intersection of Montreal Road
Route 312	From St. Peters to St. Peters Dump
Route 315	From Wood Islands to Route 4
Route 321	From Route 2 to Martinvale
Route 326	From Route 17 to Route 4 in Montague
Route 340	From Route 2 to Route 310

OTHER UNNUMBERED ROUTES

-
Cameron Road, New Haven, from Route 1 to end of pavement
Crapaud Back Road
Dalton Avenue, Tignish, Route 14 to Route 12
Red Head Head Wharf Road, from 2 to Wharf
Sleepy Hollow Road, from Route 236 West 1.5 km
Smallman Road from Route 142, 1.27 km North
Upton Road from Trans Canada Highway to Charlottetown
Bypass Route 1

SCHEDULE 2

Revoked by EC481/10

Schedule 3

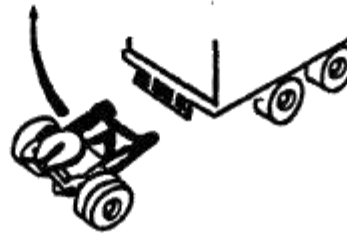
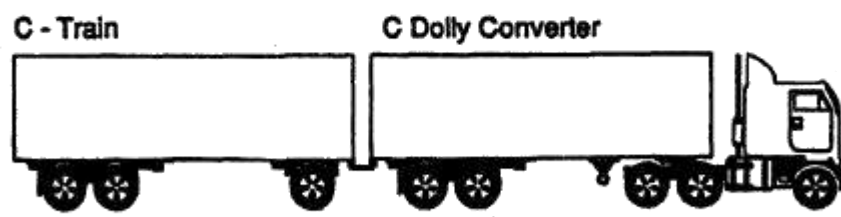
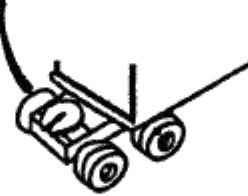
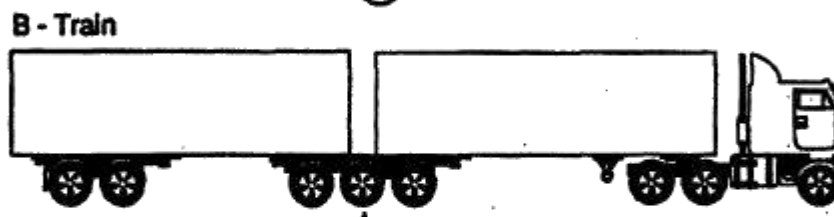
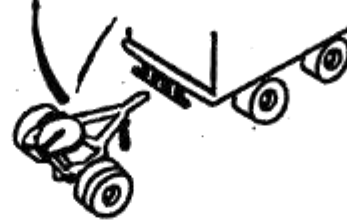
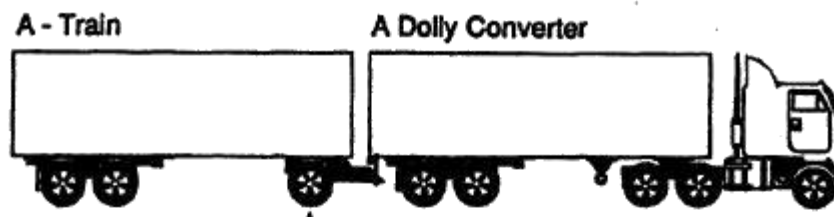

Schedule 4
(Sections 2, 5, 7, 9, 13, 16)

Category 1: Tractor Semi-trailer

Part 1 - Dimension Limits

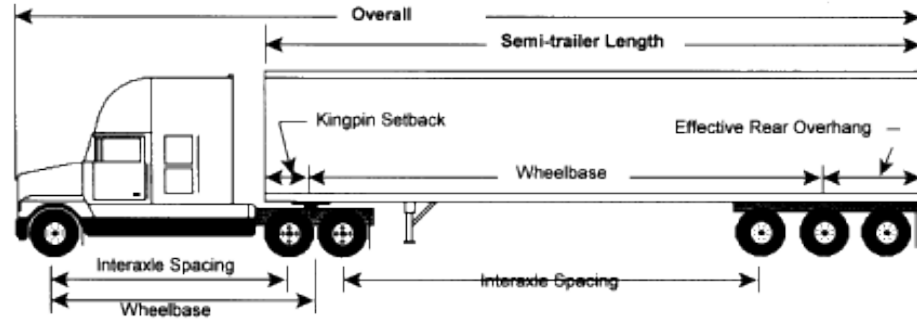

DIMENSIONS	MINIMUM AND MAXIMUM ALLOWABLE DIMENSION LIMIT
Overall Length	Maximum 23 m
Overall Width	Maximum 2.6 m
Overall Height	Maximum 4.15 m
Tractor	
Wheelbase	Maximum 6.2 m*
Tandem Axle Spread	Minimum 1.2 m/Maximum 1.85 m
Front Overhang	Maximum 1.0 m
Semi Trailer	
Length	Maximum 16.2 m
Wheelbase	Minimum 6.25 m/Maximum 12.5 m
Kingpin Setback	Maximum 2.0 m radius
Effective Rear Overhang	Maximum 35% of wheelbase
Tandem Axle Spread	Minimum 1.2 m/Maximum 1.85 m
Tridem Axle Spread	Minimum 2.4 m/Maximum 3.7 m
Track Width	Minimum 2.5 m/Maximum 2.6 m
Rear Overhang	Maximum 2.0 m
Interaxle Spacings	
Single Axle to Single, Tandem or Tridem Axle	Minimum 3.0 m
Tandem Axle to Tandem Axle	Minimum 5.0 m
Tandem Axle to Tridem Axle	Minimum 5.5 m

* A tractor wheelbase can be up to a maximum of 7.2 m, if the wheelbase of the semi-trailer is not greater than the wheelbase as set out in Table 1.

Table 1	
Maximum Semi-trailer Wheelbases	
Tractor Wheelbase	Maximum Semi-trailer Wheelbase
> 6.2 m to 6.3 m	12.47 m
> 6.3 m to 6.4 m	12.40 m
> 6.4 m to 6.5 m	12.33 m
> 6.5 m to 6.6 m	12.27 m
> 6.6 m to 6.7 m	12.20 m
> 6.7 m to 6.8 m	12.13 m
> 6.8 m to 6.9 m	12.07 m
> 6.9 m to 7.0 m	12.00 m
> 7.0 m to 7.1 m	11.93 m
> 7.1 m to 7.2 m	11.87 m

Part 2 - Weight Limits

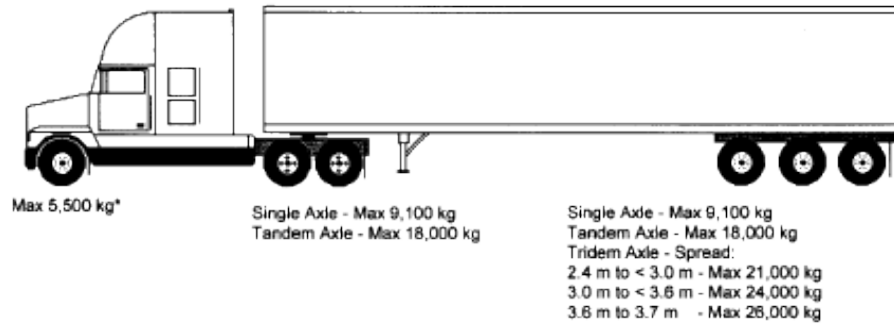

WEIGHT		MAXIMUM ALLOWABLE WEIGHT LIMIT
Axle Weight		
Steering Axle		Maximum 5,500 kg*
Single Axle (dual tires)		Maximum 9,100 kg
Tandem Axle		
Axle Spread 1.2 m to 1.85 m		Maximum 18,000 kg
Tridem Axle		
Axle Spread 2.4 m - less than 3.0 m		Maximum 21,000 kg
Axle Spread 3.0 m - less than 3.6 m		Maximum 24,000 kg
Axle Spread 3.6 m - 3.7 m		Maximum 26,000 kg
Gross Vehicle Weight Limit		
Three Axles		Maximum 23,700 kg
Four Axles		Maximum 32,600 kg
Five Axles		Maximum 41,500 kg
Six Axles	- with 2.4 <3.0 spread tridem	Maximum 44,500 kg
	- with 3.0 m to <3.6 m spread tridem	Maximum 47,500 kg
	- with 3.6 to 3.7 m spread tridem	Maximum 49,500 kg
* The steering axle weight can be as high as 9,100 kg provided the load carrying capacity of the axle, tires, and all other components is not exceeded, and the tire loading does not exceed 10 kg/mm of width. However, the Gross Vehicle Weight limit will be based on a steering axle weight of 5,500 kg.		

Category 2: A Train Double
(Schedule 2 Highways only)

Part 1 - Dimension Limits

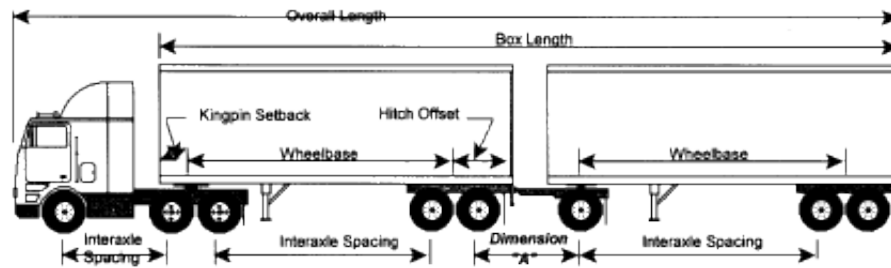

DIMENSIONS	MINIMUM AND MAXIMUM ALLOWABLE DIMENSION LIMIT
Overall Length	Maximum 25 m
Overall Width	Maximum 2.6 m
Overall Height	Maximum 4.15 m
Box Length	Maximum 20 m
Tractor	
Wheelbase	Maximum 6.2 m
Tandem Axle Spread	Minimum 1.2 m/Maximum 1.85 m
Front Overhang	Maximum 1.0 m
Lead Semi Trailer	
Wheelbase	Minimum 6.25 m
Kingpin Setback	Maximum 2.0 m radius
Tandem Axle Spread	Minimum 1.2 m/Maximum 1.85 m
Hitch Offset	Maximum 1.8 m
Track Width	Minimum 2.5 m/Maximum 2.6 m
Rear Overhang	Maximum 2.0 m
Second Semi-trailer or Full Trailer	
Wheelbase	Minimum 6.25 m
Tandem Axle Spread	Minimum 1.2 m/Maximum 1.85 m
Track Width	Minimum 2.5 m/Maximum 2.6 m
Interaxle Spacings	
Single Axle to Single or Tandem Axle	Minimum 3.0 m
Tandem Axle to Tandem Axle	Minimum 5.0 m
Dimension "A" (from the centre of last axle on the lead semi-trailer to the centre of the first axle on the converter dolly or second trailer)	Not controlled

Part 2 - Weight Limits

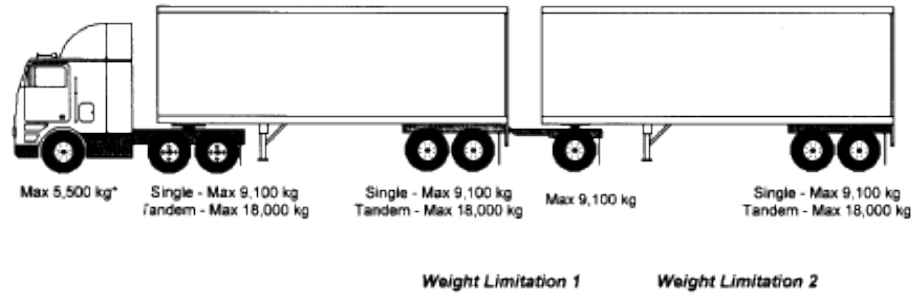

WEIGHT	MAXIMUM ALLOWABLE WEIGHT LIMIT
Axle Weight Limit	
Steering Axle	Maximum 5,500 kg*
Single Axle (dual tires)	Maximum 9,100 kg
Tandem Axle	
Axle Spread 1.2 m to 1.85 m	Maximum 18,000 kg
Weight Limitation 1 Sum of Axle Weights of Lead Semi-trailer Plus Weight of Converter Dolly Axle	If Dimension "A" is less than 3 m, the weight of the axle(s) on the lead semi-trailer plus the weight of the converted dolly axle(s) is limited to a maximum of 18,000 kg for a two axle group or a maximum of 24,000 kg for a three axle group.
Weight Limitation 2 Sum of Axle Weights of Full Trailer or Second Semi-trailer	The weight of the second trailer must not exceed the weight of the tractor drive axle(s) plus the weight of the axle(s) on the first semi-trailer.
Gross Vehicle Weight Limit	
Five Axles	Maximum 41,900 kg
Six Axles	Maximum 50,800 kg
Seven Axles	Maximum 53,500 kg
Eight Axles	Maximum 53,500 kg
* The steering axle weight can be as high as 9,100 kg provided the load carrying capacity of the axle, tires, and all other components is not exceeded, and the tire loading does not exceed 10 kg/mm of width. However, the Gross Vehicle Weight limit will be based on a steering axle weight of 5,500 kg.	

Category 3: B Train Double
(Schedule 2 Highways only)

Part 1 - Dimension Limits

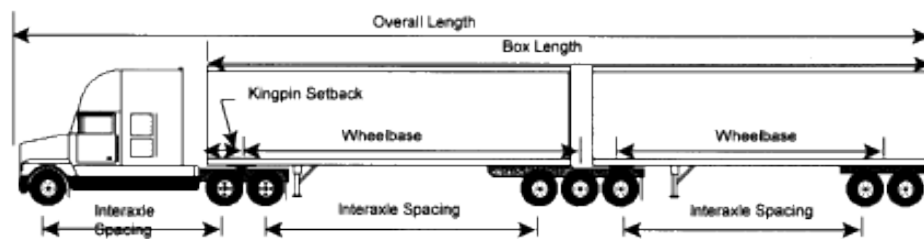

DIMENSIONS	MINIMUM AND MAXIMUM ALLOWABLE DIMENSION LIMIT
Overall Length	Maximum 25 m
Overall Width	Maximum 2.6 m
Overall Height	Maximum 4.15 m
Box Length	Maximum 20 m
Tractor	
Wheelbase	Maximum 6.2 m
Tandem Axle Spread	Minimum 1.2 m/Maximum 1.85 m
Front Overhang	Maximum 1.0 m
Lead Semi Trailer	
Wheelbase	Minimum 6.25 m
Kingpin Setback	Maximum 2.0 m radius
Tandem Axle Spread	Minimum 1.2 m/Maximum 1.85 m
Tridem Axle Spread	Minimum 2.4 m/Maximum 3.1 m
Track Width	Minimum 2.5 m/Maximum 2.6 m
Fifth Wheel Position	No more than 0.3 m behind the centre of the rearmost axle on the semi-trailer
Second Semi-trailer	
Wheelbase	Minimum 6.25 m
Tandem Axle Spread	Minimum 1.2 m/Maximum 1.85 m
Tridem Axle Spread	Minimum 2.4 m/Maximum 3.1 m
Track Width	Minimum 2.5 m/Maximum 2.6 m
Rear Overhang	Maximum 2.0 m
Sum of Semi-trailer Wheelbases	Maximum 17.0 m
Interaxle Spacings	
Single Axle to Single or Tandem Axle	Minimum 3.0 m
Tandem Axle to Tandem Axle	Minimum 5.0 m
Tandem Axle to Tridem Axle	Minimum 5.5 m

Category 3: B Train Double
(Schedule 2 Highways only)

Part 2 - Weight Limits

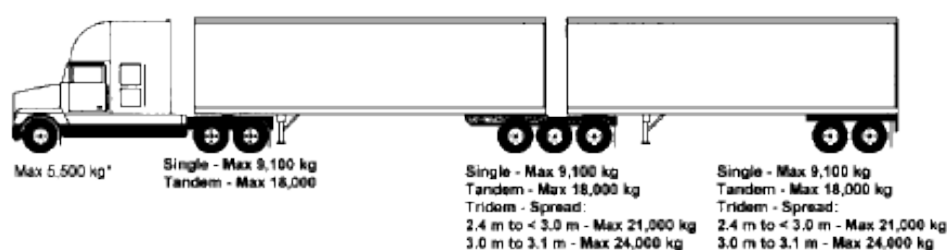

WEIGHT	MAXIMUM ALLOWABLE WEIGHT LIMIT
Axle Weight Limit	
Steering Axle	Maximum 5,500 kg*
Single Axle (dual tires)	Maximum 9,100 kg
Tandem Axle	
Axle Spread 1.2 m to 1.85 m	Maximum 18,000 kg
Tridem Axle	
Axle Spread 2.4 m to less than 3/0 m	Maximum 21,000 kg
Axle Spread 3/0 m to 3.1 m	Maximum 24,000 kg
Gross Vehicle Weight Limit	
Four Axles	Maximum 32,800 kg
Five Axles	Maximum 41,700 kg
Six Axles	Maximum 50,600 kg
Seven Axles	Maximum 59,500 kg
Eight Axles	Maximum 62,500 kg
Nine Axles	Maximum 62,500 kg
* The steering axle weight can be as high as 9,100 kg provided the load carrying capacity of the axle, tires, and all other components is not exceeded, and the tire loading does not exceed 10 kg/mm of width. However, the Gross Vehicle Weight limit will be based on a steering axle weight of 5,500 kg.	

Category 4: C Train Double
(Schedule 2 Highways only)

Part 2 - Dimension Limits

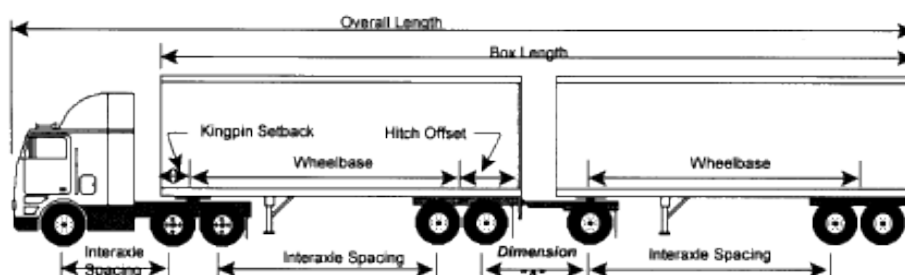

DIMENSIONS	MINIMUM AND MAXIMUM ALLOWABLE DIMENSION LIMIT
Overall Length	Maximum 25 m
Overall Width	Maximum 2.6 m
Overall Height	Maximum 4.15 m
Box Length	Maximum 20 m
Tractor	
Wheelbase	Maximum 6.2 m
Tandem Axle Spread	Minimum 1.2 m/Maximum 1.85 m
Front Overhang	Maximum 1.0 m
Lead Semi Trailer	
Wheelbase	Minimum 6.25 m
Kingpin Setback	Maximum 2.0 m radius
Tandem Axle Spread	Minimum 1.2 m/Maximum 1.85 m
Hitch Offset	Maximum 1.8 m
Track Width	Minimum 2.5 m/Maximum 2.6 m
Second Semi-trailer or Full Trailer	
Wheelbase	Minimum 6.25 m
Tandem Axle Spread	Minimum 1.2 m/Maximum 1.85 m
Track Width	Minimum 2.5 m/Maximum 2.6 m
Rear Overhang	Maximum 2.0 m
C Dolly Drawbar Length	Maximum 2.0 m
Interaxle Spacings	
Single Axle to Single or Tandem Axle	Minimum 3.0 m
Tandem Axle to Tandem Axle	Minimum 5.0 m
Dimension "A" (from the centre of the last axle on the lead semi-trailer to centre of the first axle on the converter dolly or second trailer)	Not Controlled

Category 4: C Train Double
(Schedule 2 Highways Only)

Part 2 - Weight Limits

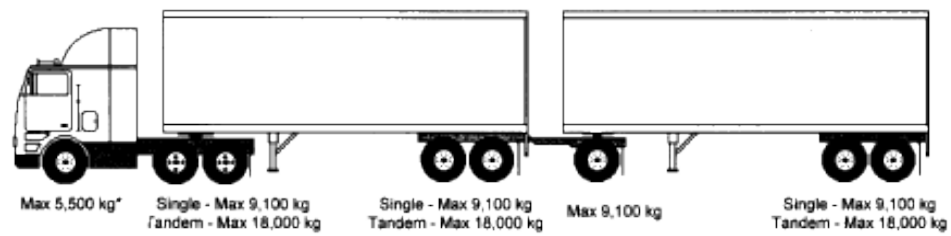

WEIGHT	MAXIMUM ALLOWABLE WEIGHT LIMIT
Axle Weight Limit	
Steering Axle	Maximum 5,500 kg*
Single Axle (dual tires)	Maximum 9,100 kg
Tandem Axle	
Axle Spread 1.2 m to 1.85 m	Maximum 18,000 kg
Weight Limitation 1	
Sum of Axle Weights of Lead Semi-trailer Plus Weight of Converter Dolly Axle	If Dimension "A" is less than 3 m, the weight of the axle(s) on the lead semi-trailer plus the weight of the converted dolly axle(s) is limited to a maximum of 18,000 kg for a two axle group or a maximum of 24,000 kg for a three axle group.
Weight Limitation 2	
Sum of Axle Weights of Full Trailer or Second Semi-trailer	The weight of the second trailer must not exceed the weight of the tractor drive axle(s) plus the weight of the axle(s) on the first semi-trailer.
Gross Vehicle Weight Limit	
Five Axles	Maximum 41,900 kg
Six Axles	Maximum 50,800 kg
Seven Axles	Maximum 55,600 kg
Eight Axles	Maximum 58,500 kg
* The steering axle weight can be as high as 9,100 kg provided the load carrying capacity of the axle, tires, and all other components is not exceeded, and the tire loading does not exceed 10 kg/mm of width. However, the Gross Vehicle Weight limit will be based on a steering axle weight of 5,500 kg.	

CATEGORY 5: STRAIGHT TRUCK

Part 1 - Dimension Limits

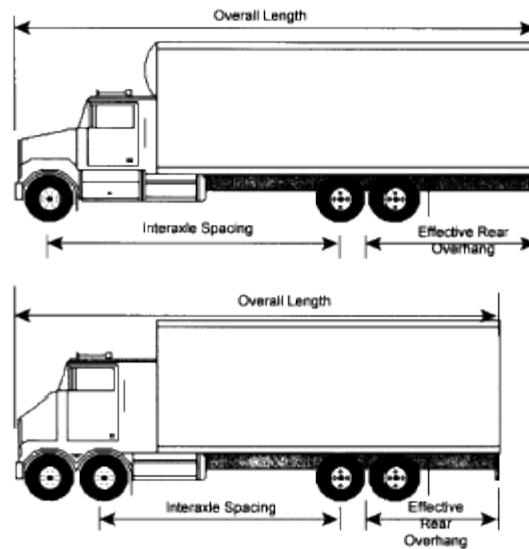

DIMENSIONS	MINIMUM AND MAXIMUM ALLOWABLE DIMENSION LIMIT
Overall Length	Maximum 12.5 m
Overall Width	Maximum 2.6 m
Overall Height	Maximum 4.15 m
Box Length	Not Controlled
Wheelbase	Not Controlled
Tandem Axle Spread	Minimum 1.2 m/Maximum 2.2 m
Effective Rear Overhang	Maximum 4.0 m
Rear Overhang	Maximum 2.0 m
Front Overhang	Maximum 1.0 m
Interaxle Spacings	
Single Axle to Single or Tandem Axle	Minimum 3.0 m
Tandem Steering Axle to Tandem Axle	Minimum 3.65 m

Part 2 - Weight Limits

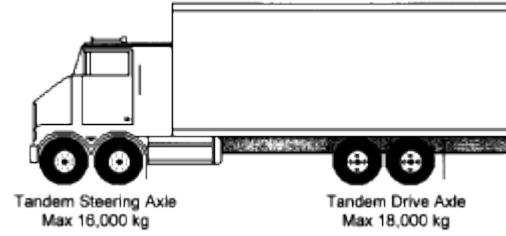
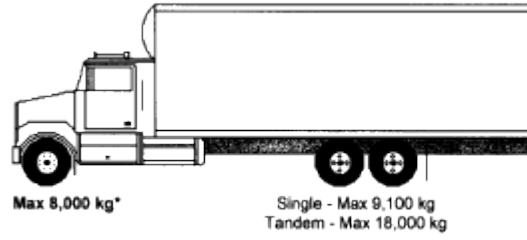

WEIGHT		MAXIMUM ALLOWABLE WEIGHT LIMIT
Axle Weight		Maximum 8,000 kg*
Steering Axle	- single axle, single tires	Maximum 16,000 kg
	- tandem axle, single tires	Maximum 9,100 kg
Tandem Axle		
Axle Spread 1.2 m to 2.2 m		Maximum 18,000 kg
Gross Vehicle Weight Limit		
Two Axles		Maximum 17,100 kg
Three Axles		Maximum 26,000 kg
Four Axles		Maximum 34,000 kg
* The steering axle weight can be as high as 9,100 kg provided the load carrying capacity of the axle, tires, and all other components is not exceeded, and the tire loading does not exceed 10 kg/mm of width. However, the Gross Vehicle Weight limit will be based on a steering axle weight of 8,000 kg for single axle straight trucks.		

(EC656/10)

Category 6: Truck - Pony Trailer Combination

Part 1 - Dimension Limits

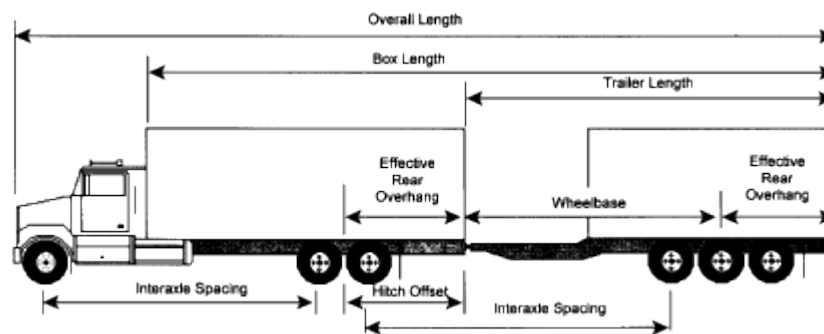

DIMENSIONS	MINIMUM AND MAXIMUM ALLOWABLE DIMENSION LIMIT
Overall Length	Maximum 23 m
Overall Width	Maximum 2.6 m
Overall Height	Maximum 4.15 m
Box Length	Maximum 20 m
Tractor	
Front Overhang	Maximum 1.0 m
Length	Minimum 12.5 m
Wheelbase	Not Controlled
Tandem Axle Spread	Minimum 1.2 m/Maximum 1.85 m
Effective Rear Overhang	Minimum 4.0 m
High Offset	Maximum 1.8 m
Rear Overhang	Minimum 2.0 m
Pony Trailer*	
Length	Maximum 12.5 m
Wheelbase	Minimum 6.25 m
Tandem Axle Spread	Minimum 1.2 m/Maximum 1.85 m
Tridem Axle Spread	Minimum 2.4 m/Maximum 3.7 m
Track Width	Minimum 2.5 m/Maximum 2.6 m
Effective Rear Overhang	Maximum 4.0 m
Rear Overhang	Maximum 2.0 m
Interaxle Spacings	
Single Axle to Single or Tandem Axle	Minimum 3.0 m
Tandem Axle to Tandem Axle	Minimum 5.0 m
Tandem Axle to Tridem Axle	Minimum 5.5 m
* Dimension limits not applicable to pony trailers with Gross Vehicle Weight Rating of less than 10,000 kg. (EC481/10)	

Category 6: Truck - Pony Trailer Combinations

Part 2 - Weight Limits

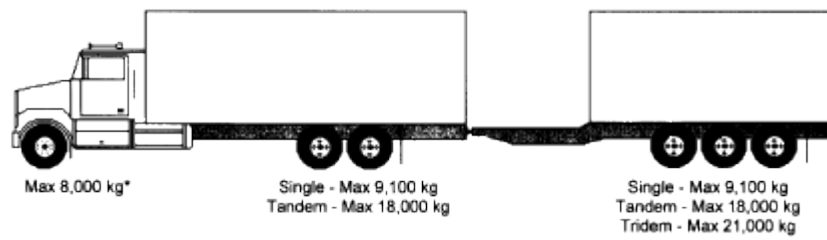

WEIGHT	MAXIMUM ALLOWABLE WEIGHT LIMIT
Axle Weight Limit	
Steering Axle	Maximum 8,000 kg*
Single Axle (dual tires)	Maximum 9,100 kg
Tandem Axle	
Axle Spread 1.2 m to 1.85 m	Maximum 18,000 kg
Tridem Axle	
Axle Spread 2.4 m - 2.5 m	Maximum 21,000 kg
Gross Vehicle Weight Limit	
Three Axles	Maximum 26,200 kg
Four Axles	Maximum 35,100 kg
Five Axles	Maximum 44,000 kg
Six Axles	Maximum 47,000 kg
* The steering axle weight can be as high as 9,100 kg provided the load carrying capacity of the axle, tires, and all other components is not exceeded, and the tire loading does not exceed 10 kg/mm of width. However, the Gross Vehicle Weight limit will be based on a steering axle weight of 8,000 kg for single axle straight trucks.	

Category 7: Tandem Steering Axle Truck - Pony Trailer Combinations

Part 1 - Dimension Limits

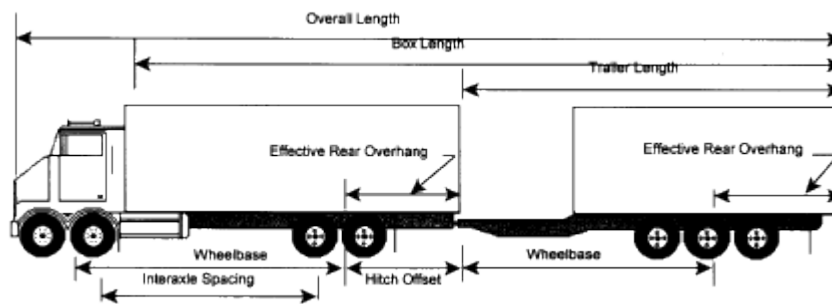

DIMENSION	MINIMUM AND MAXIMUM ALLOWABLE DIMENSION LIMIT
Overall Length	Maximum 23 m
Overall Width	Maximum 2.6 m
Overall Height	Maximum 4.15 m
Box Length	Maximum 20 m
Truck	
Front Overhang	Maximum 1.0 m
Length	Minimum 12.5 m
Wheelbase	Not Controlled
Tandem Steering Axle Spread	Minimum 1.2 m/Maximum 2.2 m
Tandem Drive Axle Spread	Minimum 1.2 m/Maximum 1.85 m
Effective Rear Overhang	Maximum 4.0 m
Rear Overhang	Maximum 2.0 m
Hitch Offset	Maximum 1.8 m
Rear Overhang	Minimum 2.0 m
Pony Trailer*	
Length	Maximum 12.5 m
Wheelbase	Minimum 6.25 m
Tandem Axle Spread	Minimum 1.2 m/Maximum 1.85 m
Tridem Axle Spread	Minimum 2.4 m/Maximum 3.7 m
Track Width	Minimum 2.5 m/Maximum 2.6 m
Effective Rear Overhang	Maximum 4.0 m
Rear Overhang	Maximum 2.0 m
Interaxle Spacings	
Tandem Steering Axle to Tandem Drive Axle	Minimum 3.65 m
Single Axle to Single, Tandem or Tridem Axle	Minimum 3.0 m
Tandem Axle to Tandem Axle	Minimum 5.0 m
Tandem Axle to Tridem Axle	Minimum 5.5 m
* Limits not applicable to pony trailers with Gross Vehicle Weight Rating of less than 10,000 kg. (EC481/10)	

Part 2 - Weight Limits

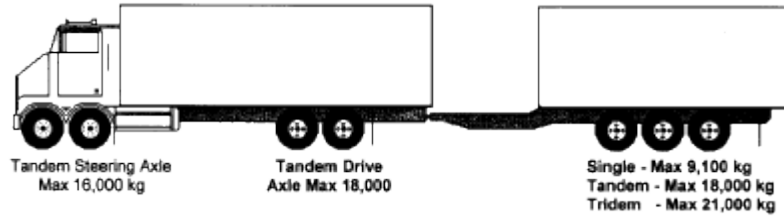

WEIGHT	MAXIMUM ALLOWABLE WEIGHT LIMIT
Axle Weight Limit	
Truck	
Tandem Steering Axle: Spread 1.2 m to 2.2 m	Maximum 16,000 kg
Tandem Drive Axle: Spread 1.2 m to 1.85 m	Maximum 18,000 kg
Trailer	
Single Axle (dual tires)	Maximum 9,100 kg
Tandem Axle: Spread 1.2 m to 1.85 m	Maximum 18,000 kg
Tridem Axle: Spread 2.4 m - 3.7 m	Maximum 21,000 kg
Gross Vehicle Weight Limit	
Five Axles	Maximum 43,100 kg
Six Axles	Maximum 50,000 kg
Seven Axles	Maximum 53,500 kg
	(EC481/10)

Category 8: Truck - Full Trailer Combination

Part 1 - Dimension Limits

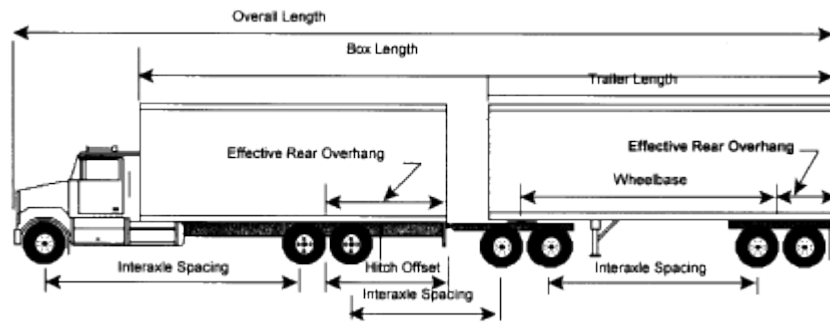

DIMENSION	MINIMUM AND MAXIMUM ALLOWABLE DIMENSION LIMIT
Overall Length	Maximum 23 m
Overall Width	Maximum 2.6 m
Overall Height	Maximum 4.15 m
Box Length	Maximum 20 m
Truck	
Front Overhang	Maximum 1.0 m
Length	Maximum 12.5 m
Wheelbase	Not Controlled
Tandem Axle Spread	Minimum 1.2 m/Maximum 1.85 m
Effective Rear Overhang	Maximum 4.0 m
Hitch Offset	Maximum 1.8 m
Rear Overhand	Maximum 2.0 m
Full Trailer*	
Length	Maximum 12.5 m
Wheelbase	Minimum 6.25 m
Tandem Axle Spread	Minimum 1.2 m/Maximum 1.85 m
Track Width	Minimum 2.5 m/Maximum 2.6 m
Effective Rear Overhang	Maximum 35% of wheelbase
Rear Overhang	Maximum 2.0 m
Converter Dolly	The use of a double drawbar or C dolly is not permitted on this combination
Interaxle Spacings	
Single Axle to Single, Tandem or Tridem Axle	Minimum 3.0 m
Tandem Axle to Tandem Axle	Minimum 5.0 m

Part 2 - Weight Limits

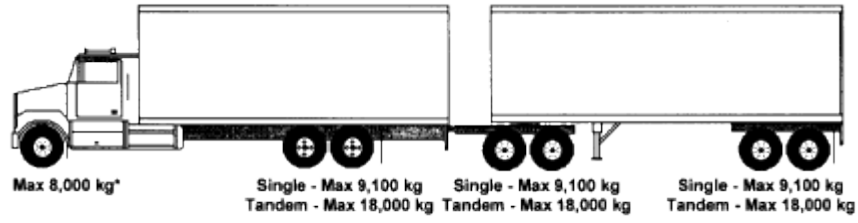

Weight Limitation 1

WEIGHT	MAXIMUM ALLOWABLE WEIGHT LIMIT
Axle Weight Limit	
Steering Axle	Maximum 8,000 kg*
Single Axle (dual tires)	Maximum 9,100 kg
Tandem Axle	
Axle Spread 1.2 m to 1.85 m	Maximum 18,000 kg
Weight Limitation 1	
Sum of Axle Weights of Full Trailer	
4 Axle Truck-Trailer Combination	Maximum 17,000 kg
5 Axle Truck-Trailer Combination	Maximum 17,000 kg
6 Axle Truck-Trailer Combination	Maximum 24,000 kg
7 Axle Truck-Trailer Combination	Maximum 31,000 kg
Gross Vehicle Weight Limit	
Four Axles	Maximum 34,100 kg
Five Axles	Maximum 43,000 kg
Six Axles	Maximum 50,000 kg
Seven Axles	Maximum 53,500 kg
* The steering axle weight can be as high as 9,100 kg provided the load carrying capacity of the axle, tires, and all other components is not exceeded, and the tire loading does not exceed 10 kg/mm of width. However, the Gross Vehicle Weight limit will be based on a steering axle weight of 8,000 kg.	

Category 9: Tandem Steering Axle Truck - Full Trailer Combinations

Part 1 Dimension Limits

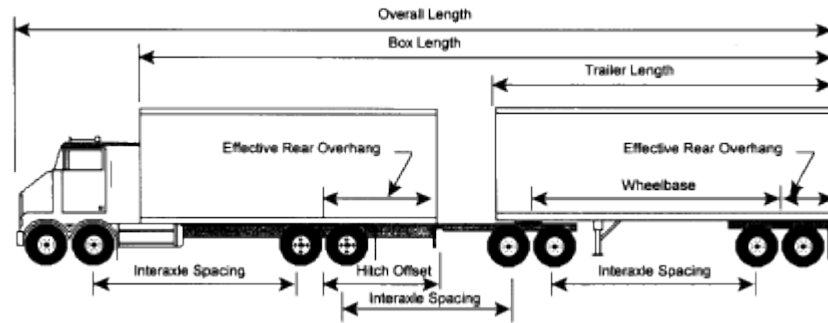

DIMENSION	MINIMUM AND MAXIMUM ALLOWABLE DIMENSION LIMIT
Overall Length	Maximum 23 m
Overall Width	Maximum 2.6 m
Overall Height	Maximum 4.15 m
Box Length	Maximum 20 m
Truck	
Front Overhang	Maximum 1.0 m
Length	Maximum 12.5 m
Wheelbase	Not Controlled
Tandem Steering Axle Spread	Minimum 1.2 m/Maximum 2.2 m
Tandem Drive Axle Spread	Minimum 1.2 m/Maximum 1.85 m
Effective Rear Overhang	Maximum 4.0 m
Hitch Offset	Maximum 1.8 m
Rear Overhand	Maximum 2.0 m
Full Trailer	
Length	Maximum 12.5 m
Wheelbase	Minimum 6.25 m
Tandem Axle Spread	Minimum 1.2 m/Maximum 1.85 m
Track Width	Minimum 2.5 m/Maximum 2.6 m
Effective Rear Overhang	Maximum 35% of wheelbase
Rear Overhang	Maximum 2.0 m
Converter Dolly	The use of a double drawbar or C dolly is not permitted on this combination
Interaxle Spacings	
Tandem Steering Axle to Tandem Drive Axle	Minimum 3.65 m
Single Axle to Single, Tandem or Tridem Axle	Minimum 3.0 m
Tandem Axle to Tandem Axle	Minimum 5.0 m

Part 2 - Weight Limits

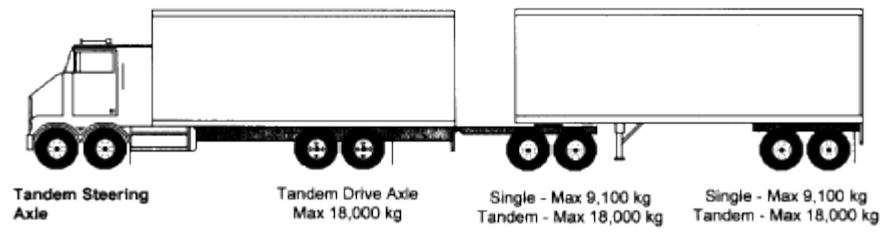

WEIGHT	MAXIMUM ALLOWABLE WEIGHT LIMIT
Axle Weight Limit	
Tandem Steering Axle	Maximum 16,000 kg
Single Axle (dual tires)	Maximum 9,100 kg
Tandem Axle	
Axle Spread 1.2 m to 1.85 m	Maximum 18,000 kg
Gross Vehicle Weight Limit	
Six Axles	Maximum 51,000 kg
Seven Axles	Maximum 53,500 kg
Eight Axles	Maximum 53,500 kg

Category 10 - Intercity Bus and Motor Home
(EC481/10)

Part 1 - Dimension Limits

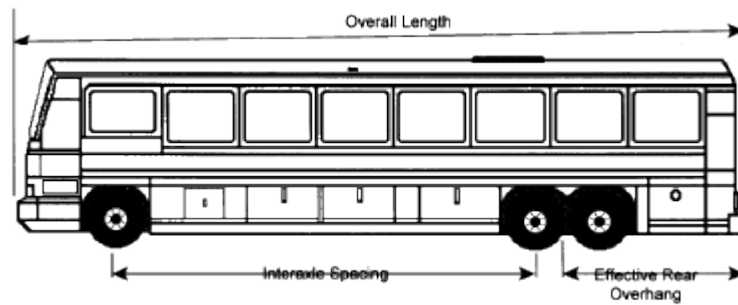

DIMENSION	MINIMUM AND MAXIMUM ALLOWABLE DIMENSION LIMIT
Overall Length	Maximum 14 m
Overall Width	Maximum 2.6 m
Overall Height	Maximum 4.15 m
Wheelbase	Not Controlled
Tandem Axle Spread	Minimum 1.2 m/Maximum 1.85 m
Effective Rear Overhang	Maximum 4.0 m
Axle Requirements	
Overall length 12.5 m or less	Not controlled
Overall length greater than 12.5 m	Minimum three axles

Part 2 - Weight Limits

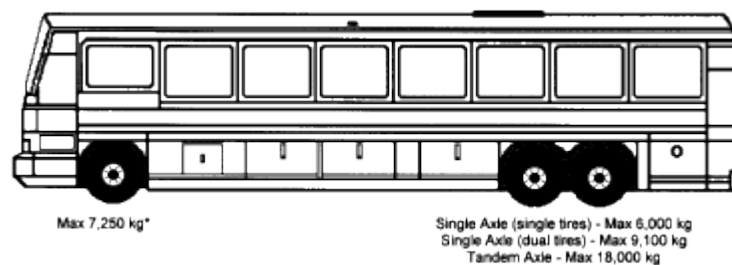

WEIGHT	MAXIMUM ALLOWABLE WEIGHT LIMIT
Axle Weight	
Steering Axle	Maximum 7,250kg ¹
Single Axle (dual tires)	Maximum 9,100 kg ²
Single Axle (single tires)	Maximum 6,000 kg ²
Tandem Axle (dual tires on box axles)	Maximum 18,000 kg ²
Gross Vehicle Weight Limit	
Two Axles (4 tires)	Maximum 13,250 kg
Two Axles (6 tires)	Maximum 16,350 kg
Three Axles (8 tires)	Maximum 20,900 kg
Three Axles (10 tires)	Maximum 25,250 kg
Notes:	
1. The steering axle weight can be as high as 9,100 kg provided the load carrying capacity of the axle, tires, and all other components is not exceeded, and the tire loading does not exceed 10 kg/mm of width. However, the Gross Vehicle Weight limit will be based on a steering axle weight of 7,250 kg.	
2. Where there is more than one axle at the rear of the bus, the load carried by the group must be distributed between axles in a ratio corresponding to the number of tires on each axle.	

SCHEDULE 5
(Section 2, Roads Act Vehicle Weights and Dimensions Regulations)

Form Certifying Axle Rating

Pursuant to subsection 2(3) of the *Roads Act Vehicle Weights Regulations*

To: The Minister of Transportation and Infrastructure Renewal
P. O. Box 2000
Charlottetown, PEI
C1A 7N8

Re: Motor Vehicle
Make _____ Model _____ Year _____
Plate Number _____ VIN Number _____
Registered Owner _____

This is to certify that _____
(Name of person or incorporated company)
is the agent/dealer (please underline one or both, as appropriate) for the manufacturer of the above vehicle, and that the following are the correct ratings for this vehicle:

Tires _____ Steering _____ Springs _____
Wheels _____ Brakes _____ Axles _____
Frame _____ (The above ratings are in kilograms.)

Dated at _____, this ____ day of _____, 20__.

_____ Address	_____ Name of Agent/Dealer, per
_____ Telephone No.	_____ Signature
_____ Occupation/Position	_____ Name (Please Print)

(Pursuant to subsection 2(7) of the *Roads Act Vehicle Weights Regulations* it is an offence to make an untrue or false statement on this form, or to knowingly submit a form containing a false or untrue statement.)
(EC481/10)

Schedule 6

Weight Limit Knockdown Formula

(Sections 13 and 16 of the *Roads Act Vehicle Weights and Dimensions Regulations*)

In cases where a vehicle or combination of vehicles does not comply with the minimum required interaxle spacing, the allowable gross vehicle weight will be reduced by 1,000 kg for each 500 mm, or part thereof, shortfall in minimum interaxle spacing relative to the following table:

Adjacent Axle Groups	Observed Spacing	GVW Reduction
Single Axle - Single Axle (Min 3.0 m required)	>2.95 m	0
	2.50 - 2.95 m	1,000 kg
	2.00 - 2.49 m	2,000 kg
	1.50 - 1.99 m	3,000 kg
	1.00 - 1.49 m	4,000 kg
Single Axle - Tandem (Min 3.0 m required)	>2.95 m	0
	2.50 - 2.95 m	1,000 kg
	2.00 - 2.49 m	2,000 kg
	1.50 - 1.99 m	3,000 kg
	1.00 - 1.49 m	4,000 kg
Single - Tridem (Min 3.0 m required)	>2.95 m	0
	2.50 - 2.95 m	1,000 kg
	2.00 - 2.49 m	2,000 kg
	1.50 - 1.99 m	3,000 kg
	1.00 - 1.49 m	4,000 kg
Tandem - Tandem (Min 5.0 m required)	>4.95 m	0
	4.50 - 4.95 m	1,000 kg
	4.00 - 4.49 m	2,000 kg
	3.50 - 3.99 m	3,000 kg
	3.00 - 3.49 m	4,000 kg
	2.50 - 3.00 m	5,000 kg
	2.00 - 2.49 m	6,000 kg
	1.50 - 1.99 m	7,000 kg
	1.00 - 1.49 m	8,000 kg
Tandem - Tridem: (Min 5.5 m required)	>5.45 m	0
	5.00 - 5.45 m	1,000 kg
	4.50 - 4.95 m	2,000 kg
	4.00 - 4.49 m	3,000 kg
	3.50 - 3.99 m	4,000 kg
	3.00 - 3.49 m	5,000 kg
	2.50 - 3.00 m	6,000 kg
	2.00 - 2.49 m	7,000 kg
	1.50 - 1.99 m	8,000 kg
1.00 - 1.49 m	9,000 kg	

(EC1/02)